

# Versatronik® 585 & 585D BACnetIP Communication Gateway



**Document Applicable to:**  
Versatronik 585 VI/BACIP P/N 704098  
Versatronik 585D VI/BACIP P/N 704099

**Applicable Controls**  
Viessmann Vitotronic 300 GW5B Single boiler  
Viessmann Vitotronic 300 GW6B Single boiler  
Viessmann Vitotronic 300 GW6B Cascade  
Viessmann Vitotronic 300-K, MW2C (8 B2HA Boiler)

---

## Technical, Installation and Configuration Information

---

### Cautionary Statement

The information presented in this document is only to be used by those familiar with its application and use.



  
C US LR 102874

**IMPORTANT**  
Read and save these instructions for future reference

## About these instructions



Take note of all symbols and notations intended to draw attention to potential hazards or important product information. These include "WARNING", "CAUTION" and "IMPORTANT". See below.

 <b>WARNING</b>
Indicates an imminently hazardous situation which, if not avoided, could result in death, serious injury or substantial product/property damage.

→ Warnings draw your attention to the presence of potential hazards or important product information.

 <b>CAUTION</b>
Indicates an imminently hazardous situation which, if not avoided, may result in minor injury or product/property damage.

→ Cautions draw your attention to the presence of potential hazards or important product information

 <b>CAUTION</b>
Static sensitive components may be damaged by improper handling or work within the control. Ensure all possible measures are taken to eliminate build-up of static electricity.

<b>IMPORTANT</b>
------------------

→ Helpful hints for installation, operation or maintenance which pertains to the product.

## Trademark Information

Viessmann® and Vitotronic® are trademarks of Viessmann Werke GmbH & Co KG registered in the United States and other countries.

Please visit:  
[www.viessmann.ca](http://www.viessmann.ca)  
[www.viessmann.us](http://www.viessmann.us)

Echelon®, LON®, LONWORKS®, i.LON®, LNS®, LONMARK®, Neuron®, and the LonUsers logo are trademarks of Echelon Corporation registered in the United States and other countries.

Please visit:  
[www.echelon.com](http://www.echelon.com)



BACnet® is a registered trademark of the American Society of Heating, Refrigerating and Air-Conditioning Engineers, Inc., 1791 Tullie Circle NE, Atlanta, GA 30329.

For more information please visit:

[www.bacnet.org](http://www.bacnet.org)  
[www.ashrea.org](http://www.ashrea.org)

## Important Regulatory and Installation Requirements

### Codes

The installation of this unit must be in accordance with local codes.

→ Please carefully read this manual prior to attempting installation. Any warranty is null and void if these instructions are not followed.

All electrical wiring is to be done in accordance with the latest edition of CSA C22,1 Part 1 and/or local codes. In the U.S. use the National Electrical Code ANSI/NFPA 70.

→ The completeness and functionality of field-supplied electrical controls and components must be verified by those installing the device

The installing contractor must comply with the Standard of Controls and Safety Devices for Automatically-fired Boilers, ANSI/ASME CSD-1 where required by the authority having jurisdiction.

### Working on the equipment

The installation, adjustment, service and maintenance of this unit must be done by a licensed professional heating contractor or persons who are qualified and experienced in the installation, service, and maintenance of similar products. There are no user serviceable parts on this control.

 **WARNING**

More than one live circuit. See wiring diagram in this manual. Turn off power supply to control and damper/blower before servicing. Contact with live electrical components can result in serious injury or death

### Power supply

Install power supply in accordance with the regulation of the authorities having jurisdiction or in absence of such requirements, in accordance with National Codes.

---

## Purpose of Device and Operation

The Versatronik 585 gateway provides a communication translation between applicable controls and DDC systems which are capable of BACnet IP communications.

The Versatronik gateway may be either part of a control panel or stand-alone control device.

## Installation

### Mounting Versatronik Gateway—120VAC Unit

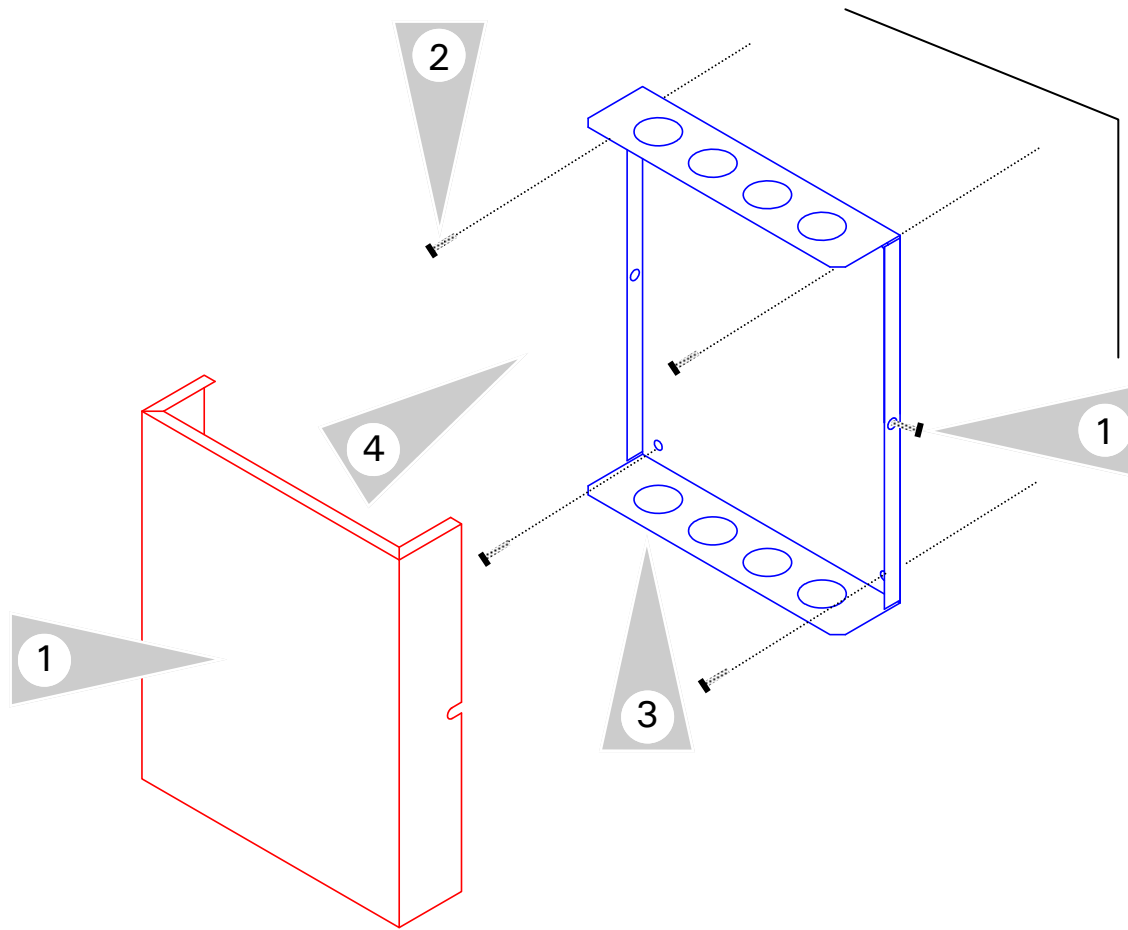

### Mounting Steps

1. Mount Versatronik 585 Gateway in a convenient location near the connected boiler controls control. Remove cover by loosening the two screws on either side of base to release the cover.
2. Fasten base to wall using field-supplied screws/fasteners.
3. Remove knockout and installed wire strain relief or box connector. Removal of remaining knockouts is required to make further connections.
4. Once all of the 120VAC and low voltage connections are complete and verified, reinstall the cover from Step 1.



### WARNING

When extending wire there is the possibility of exposure to electromagnetic interference. Avoid running wires beside or near high voltage 120/240 VAC conductors. If proximity to high voltage conductors cannot be avoided, use stranded, twisted pair of shield design wire. Ensure that only one end of the shielding is grounded.

# Installation

## Mounting Versatronik Gateway—24VAC DIN Rail Unit

### Mounting Steps

1. Mount Versatronik 585D Gateway onto DIN rail within an enclosure in a convenient location near the boiler controls.
2. Make all the necessary connections including the field-supplied 24VAC power connection.

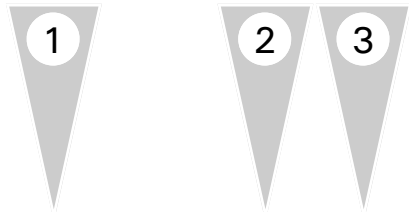
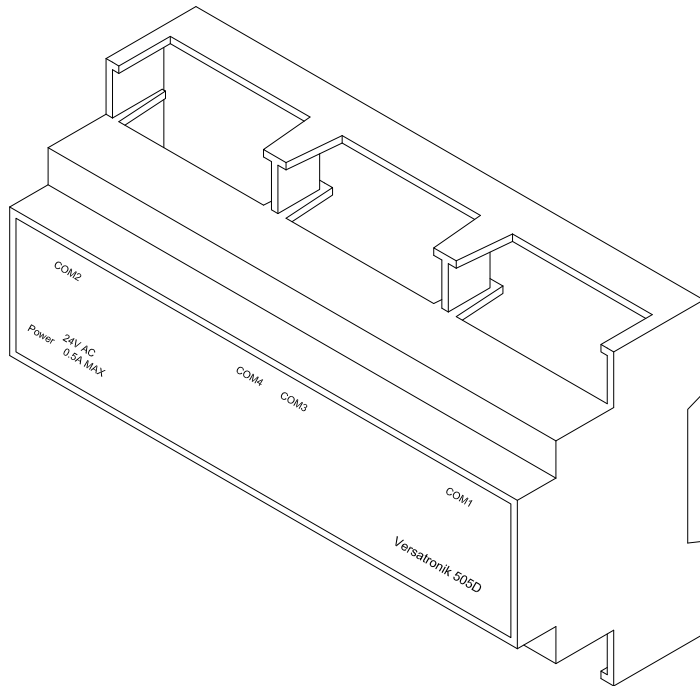

### Connection Overview

1. BACnet IP RJ45 connection
2. Control BACNET Connection RJ45
3. Paralleled BUS Connection
4. 24VAC Power Connection

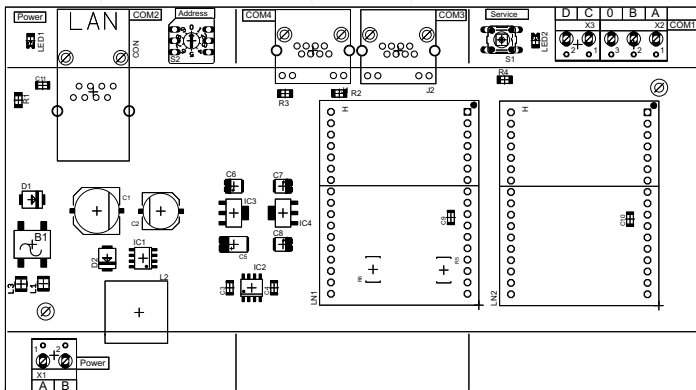

### WARNING

When extending wire there is the possibility of exposure to electromagnetic interference. Avoid running wires beside or near high voltage 120/240 VAC conductors. If proximity to high voltage conductors cannot be avoided, use stranded, twisted pair of shield design wire. Ensure that only one end of the shielding is grounded.

# Versatronik 585 Dial Setting Overview

## Rotary Dial Setting

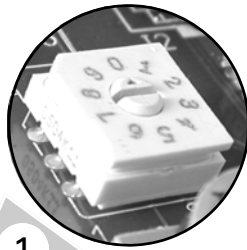

### Setting Overview

1. The rotary dial setting on the Versatronik Gateways provides addressing information for systems that may utilize a number of Versatronik Gateways.

It is not required to make adjustments to the rotary dial setting. It should be left in the factory default position setting of 0.

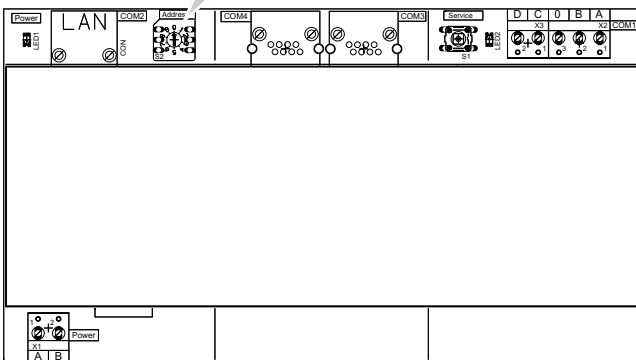
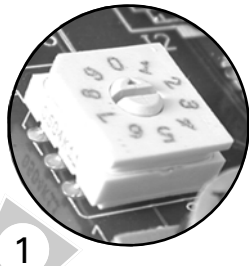
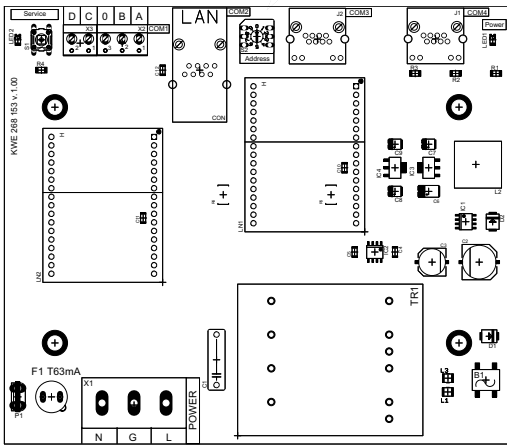

Rotary Switch Position	Participant Value
0	55
1	56
2	57
3	58
4	59
5	60
6	61
7	62

## Connection Overview—120VAC

Communication connections—Vitotronic 300 GW5B or 300 GW6B LON

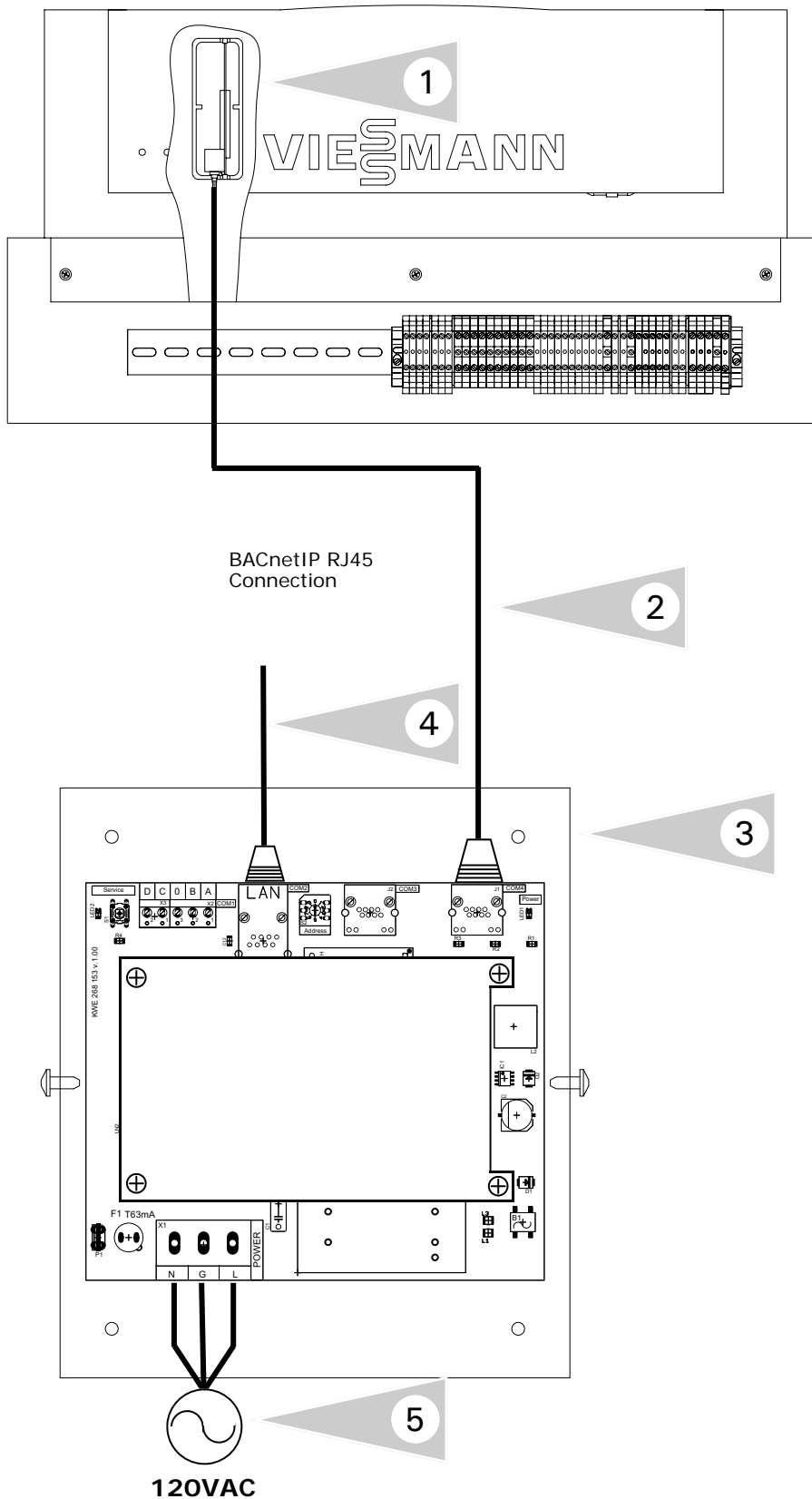

### Connection Overview

Refer to manual specific to boiler control. Ensure necessary LON communication card installed.

- 1 Control showing location of LON card and its location within.
- 2 A 3'/91cm CAT-5 cable is supplied with the gateway. The RJ45 is plugged into the control and terminates into the RJ45 socket inside of the Versatronik 585 gateway.
- 3 Versatronik 585 gateway.
- 4 The RJ45 BACnetIP communication connection plugged into Versatronik 585 gateway.
- 5 Plug-in power cord for 120VAC Versatronik 585 gateways.

## Connection Overview—24VAC

Communication connections—Vitotronic 300 GW5B or 300 GW6B LON

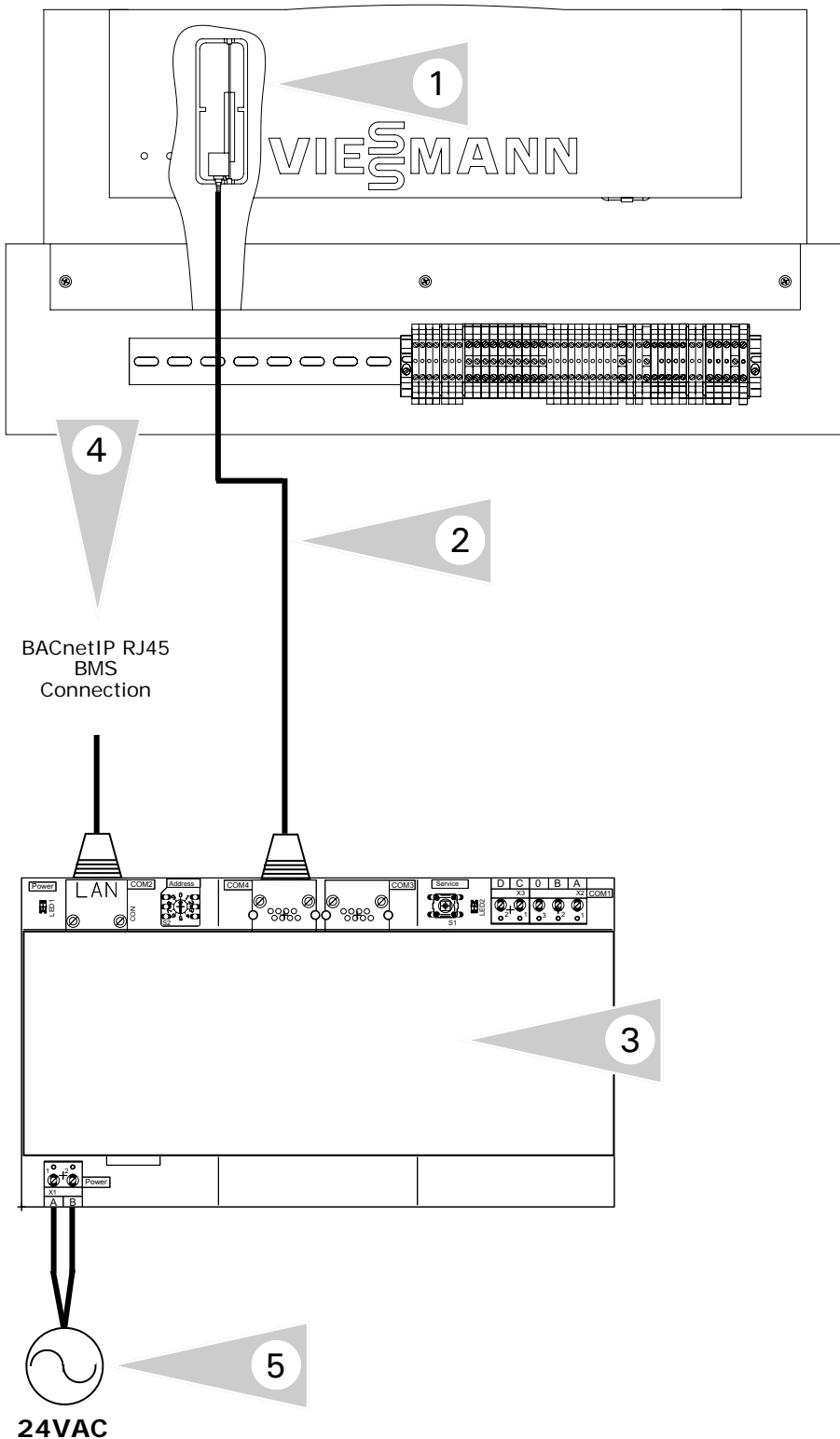

### Connection Overview

Refer to manual specific to boiler/system control. Ensure necessary LON communication card installed.

- 1 Control showing location of LON card and its location within.
- 2 A 3'/91cm CAT-5 cable is supplied with the gateway. The RJ45 is plugged into the control and terminates into the RJ45 socket inside of the Versatronik 585 gateway.
- 3 Versatronik 585 gateway.
- 4 The RJ45 BACnetIP communication connection plugged into Versatronik 585 gateway.
- 5 Field-supplied 24VAC power supply for gateway.



# Connection Overview—120VAC

Communication connections—Vitotronic 300 GW6B  
(LON communication to GW6B/GW5B/GC1B/GC1 lag controls)

BACnetIP RJ45  
Connection

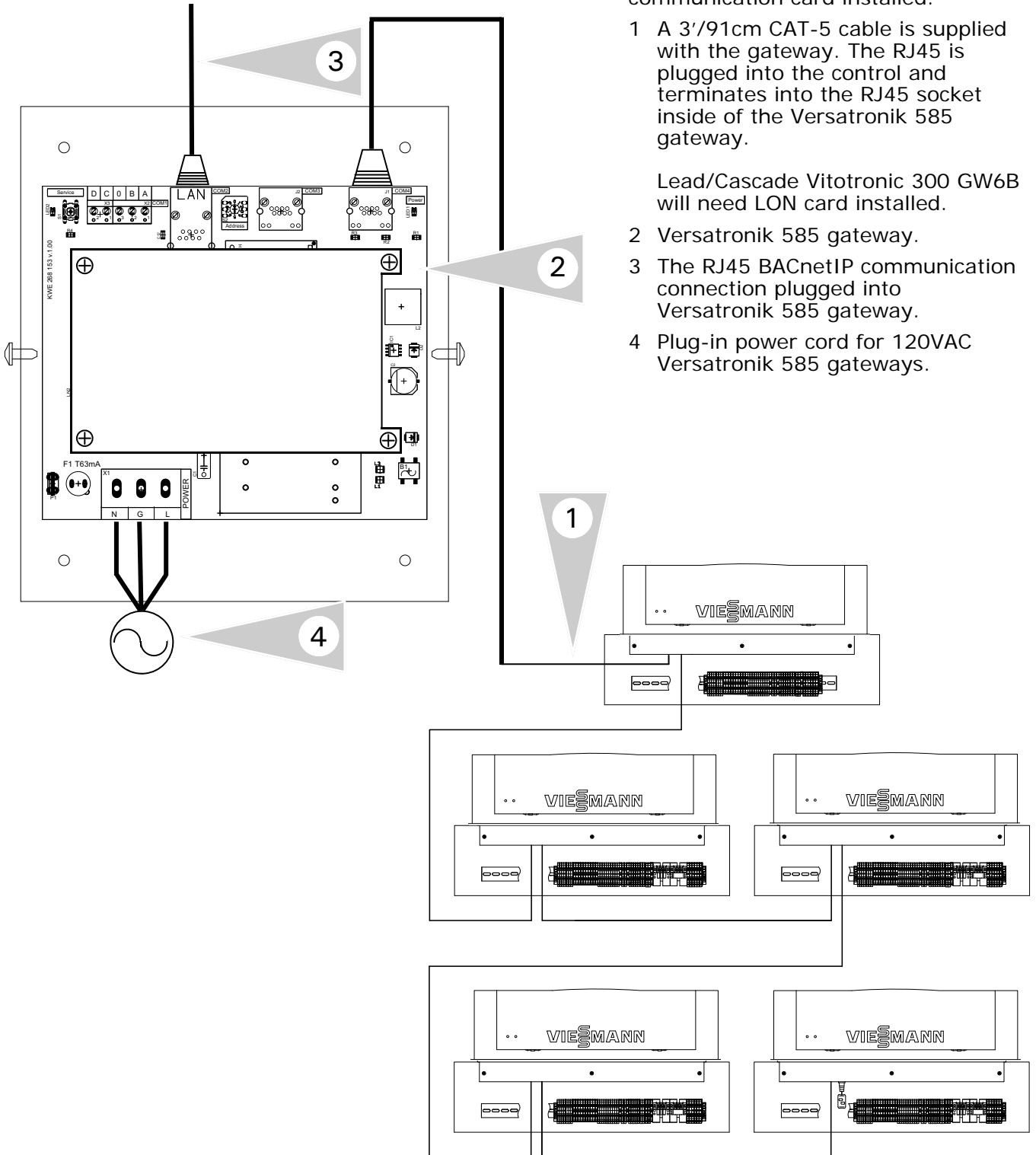

## Connection Overview

Refer to manual specific to boiler/  
system control. Ensure necessary LON  
communication card installed.

- 1 A 3'/91cm CAT-5 cable is supplied with the gateway. The RJ45 is plugged into the control and terminates into the RJ45 socket inside of the Versatronic 585 gateway.
- 2 Versatronic 585 gateway.
- 3 The RJ45 BACnetIP communication connection plugged into Versatronic 585 gateway.
- 4 Plug-in power cord for 120VAC Versatronic 585 gateways.

# Connection Overview—24VAC

Communication connections—Vitotronic 300 GW6B  
(LON communication to GW6B/GW5B/GC1B/GC1 lag controls)

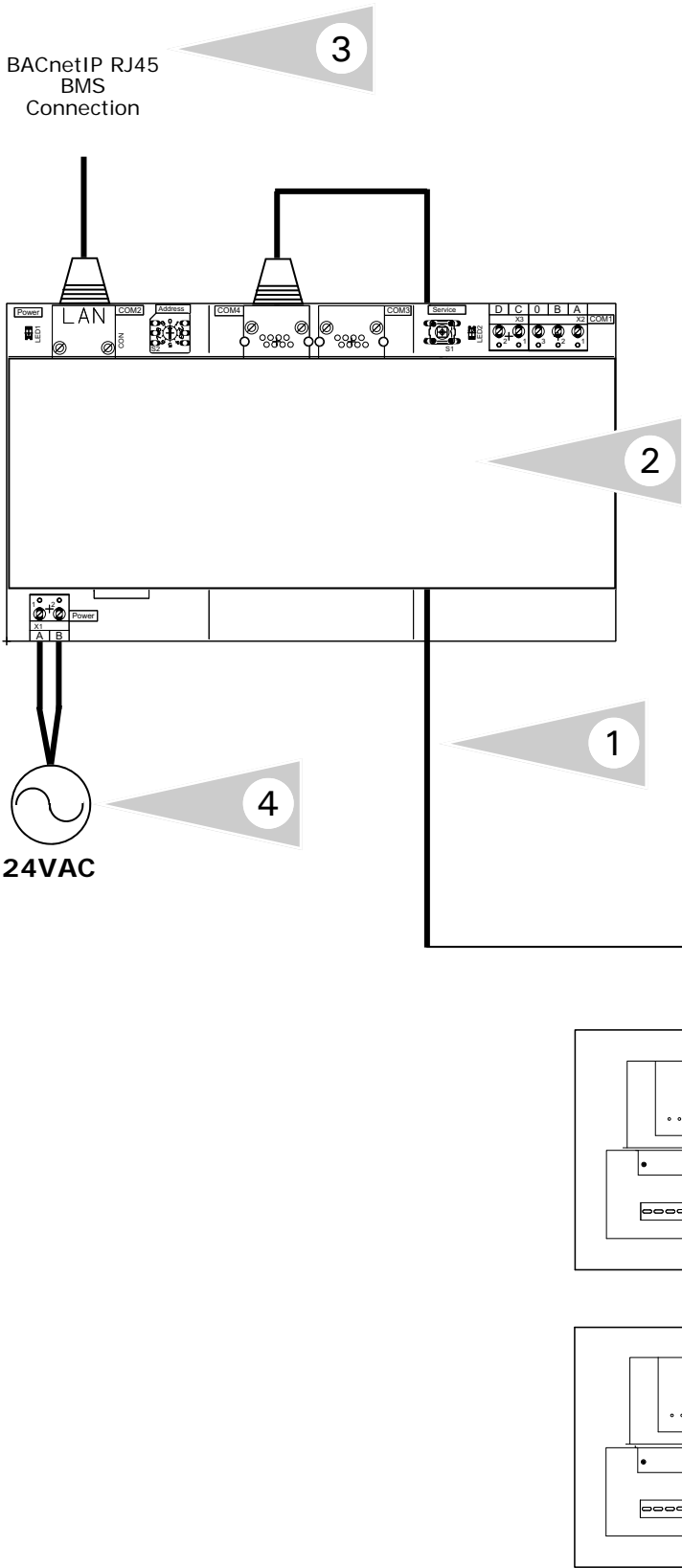

## Connection Overview

Refer to manual specific to boiler control. Ensure necessary LON communication card installed.

- 1 A 3' / 91cm CAT-5 cable is supplied with the gateway. The RJ45 is plugged into the control and terminates into the RJ45 socket inside of the Versatronik 585 gateway.
- 2 Versatronik 585 gateway.
- 3 The RJ45 BACnetIP communication connection plugged into Versatronik 585 gateway.
- 4 Field-supplied 24VAC power supply for gateway.

KWE P/N 394066 Versatronik 585 and 585D GW5/6 and B2HA BACIP Gateway V1.0 02/2016 Technical information subject to change without notice

# Connection Overview—120VAC

Communication connections—Vitotronic 300-K MW2C for Vitodens 200, B2HA

BACnetIP RJ45  
Connection

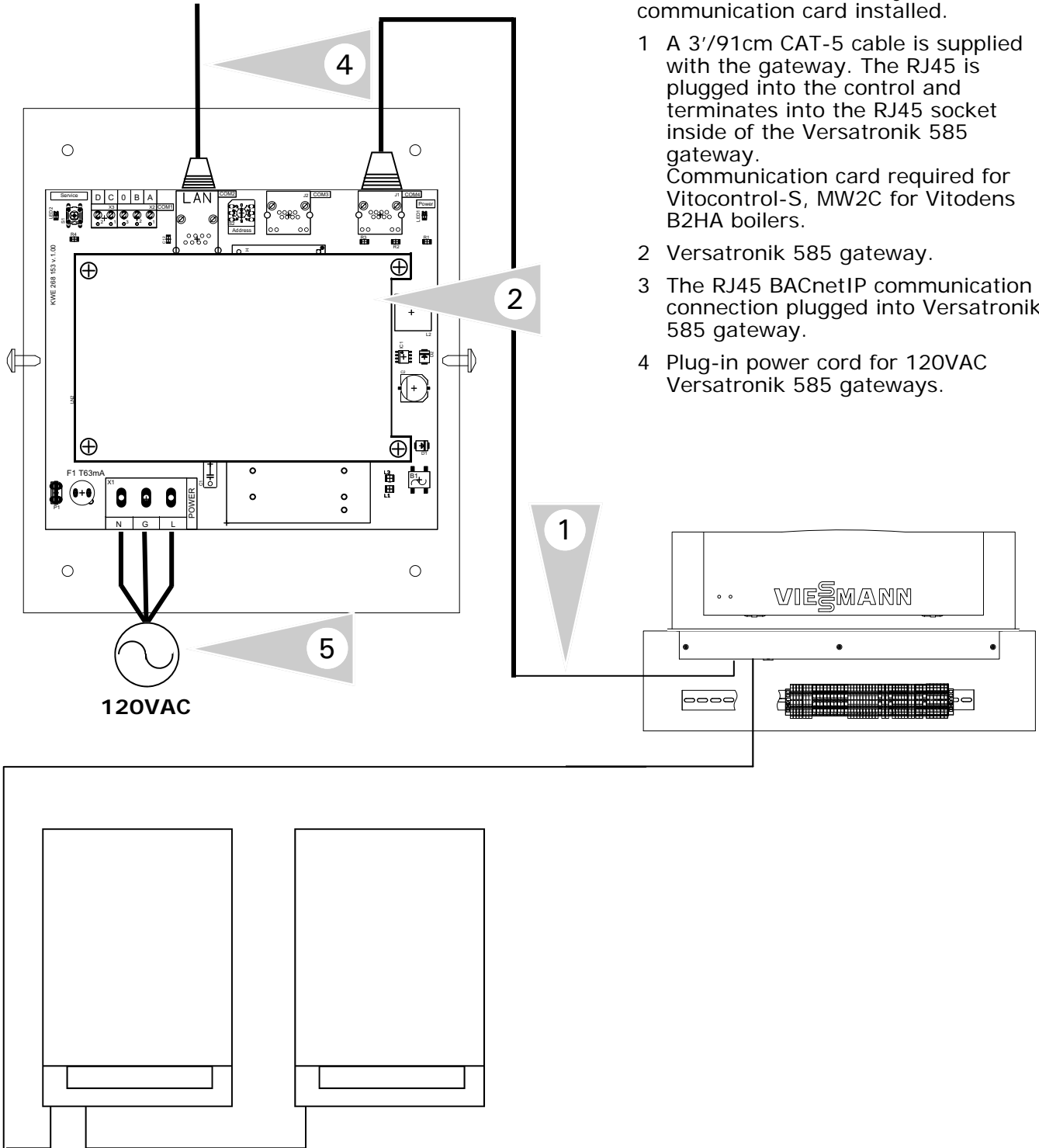

## Connection Overview

Refer to manual specific to boiler control. Ensure necessary LON communication card installed.

- 1 A 3' / 91cm CAT-5 cable is supplied with the gateway. The RJ45 is plugged into the control and terminates into the RJ45 socket inside of the Versatronic 585 gateway. Communication card required for Vitocontrol-S, MW2C for Vitodens B2HA boilers.
- 2 Versatronic 585 gateway.
- 3 The RJ45 BACnetIP communication connection plugged into Versatronic 585 gateway.
- 4 Plug-in power cord for 120VAC Versatronic 585 gateways.

# Connection Overview—24VAC

Communication connections—Vitotronic 300-K MW2C for Vitodens 200, B2HA

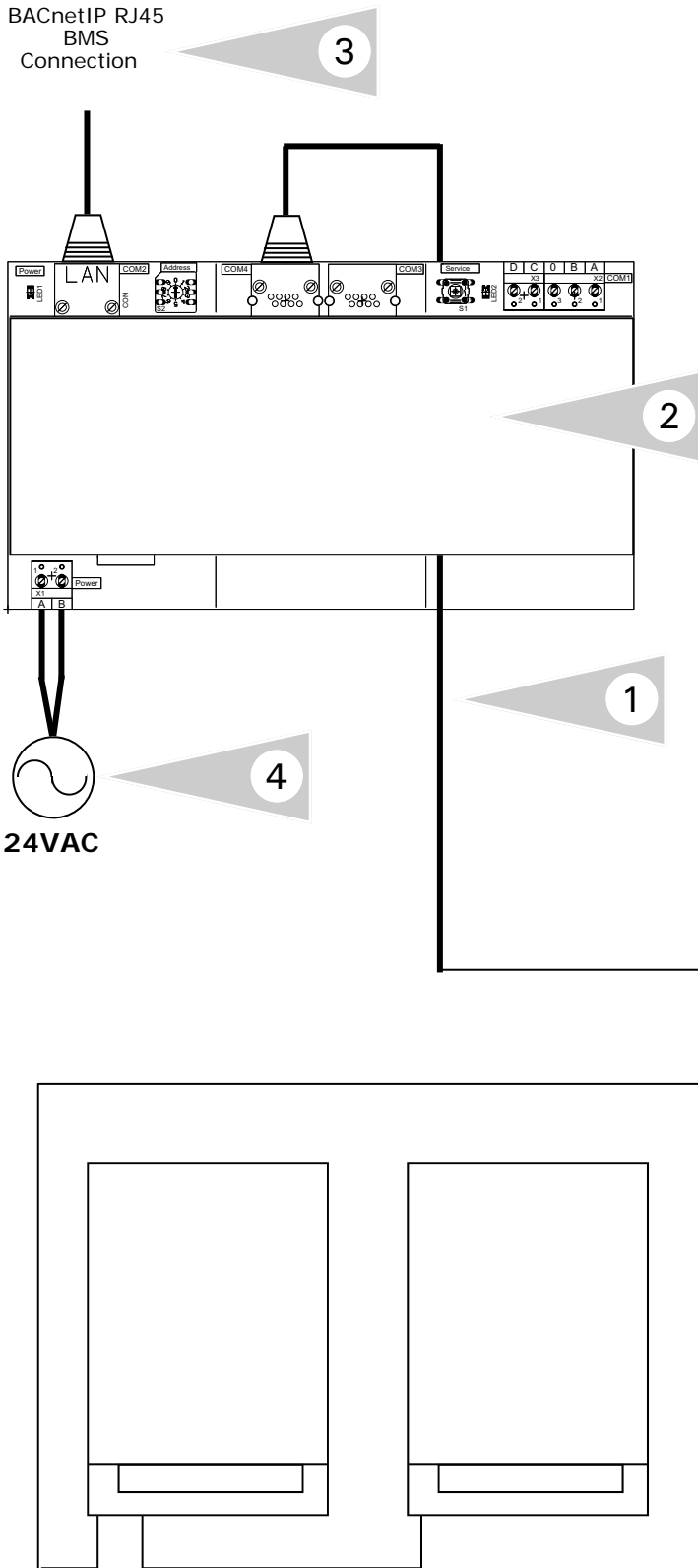

## Connection Overview

Refer to manual specific to boiler control. Ensure necessary LON communication card installed.

- 1 A 3'/91cm CAT-5 cable is supplied with the gateway. The RJ45 is plugged into the control and terminates into the RJ45 socket inside of the Versatronik 585 gateway.
- 2 Versatronik 585 gateway.
- 3 The RJ45 BACnetIP communication connection plugged into Versatronik 585 gateway.
- 4 Field-supplied 24VAC power supply for gateway.

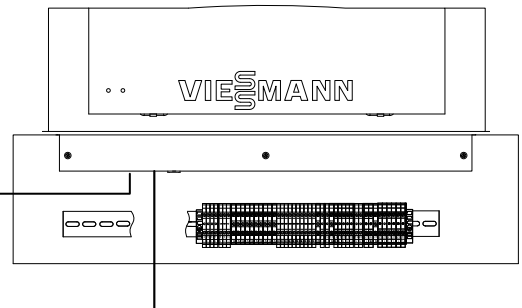

## Configuration of Gateway

### Configuring BACnet/IP Settings

Connect your computer DIRECTLY to the BACnet interface of the gateway device. With no other devices attached (an isolated network). Either set your computer's network connection to automatic IP Address (DHCP), or set your computer's IP address to 192.168.88.90 (subnet mask 255.255.255.0).

Restart the Gateway by cycling the power off and then on again.

Open a browser window and insert the following URL: <http://192.168.88.89/admin>

The default user name/password is "admin" and "admin" (without the quotes). This can be renamed in the Change Password screen. At this point you will see the Configuration pages.

### Versatronik 585 Vi/BACIP

- Home
- BACnet/IP Settings
- BACnet Device Settings
- Advanced Settings
- Restore Defaults
- Change Password
- Activate Configuration

#### BACnet/IP Settings

This page allows you to view current BACnet/IP settings, to change them or to restore them to factory defaults.

Parameter	Value	Description
IP	<input type="text" value="192.168.0.22"/>	IP address of the BACnet device.
Network Mask	<input type="text" value="255.255.255.0"/>	IP subnet mask.
Default Gateway	<input type="text" value="192.168.0.1"/>	IP address of the default gateway.
UDP Port	<input type="text" value="47808"/>	BACnet/IP UDP port number.

Copyright © 2006-2007 Cimetrics

v1.2 (EX-28m-b7092-1.2)

**IMPORTANT:** Make sure that you remember any changes made here.

## Configuration of Gateway Continued

### BACnet Device Settings

You can now reconfigure these settings according to your network requirements. Make sure that you press SAVE on every screen where you made changes. The new setting will not take effect until the Activate Configuration screen has been confirmed. These configuration pages can now be accessed through both the 192.168.88.89 Address, as well as the one you have selected.

The BACnet Device Settings screen looks like this:

### Versatronik 585 Vi/BACIP

- Home
- BACnet IP Settings
- BACnet Device Settings**
- Advanced Settings
- Restore Defaults
- Change Password
- Activate Configuration

#### BACnet Device Settings

This page allows you to view current BACnet Device settings, to change them or to restore them to factory defaults.

Parameter	Value	Description
Device ID:	<input type="text" value="1"/>	BACnet Device Instance Number.
Object Name:	<input type="text"/>	Value of the Device's Object_Name property.
Description:	<input type="text"/>	Value of the Device's Device_Description property.
Location:	<input type="text"/>	Value of the Device's Device_Location property.

Copyright © 2006-2007 Cimetrics v1.2 (EX-28m-b7092-1.2)

**NOTE:** The **Device ID** must be unique on the entire BACnet network.

The Restore Defaults and Change Password screens are very simplistic. When you select Activate Configuration, it will ask you if you want to SAVE your settings. This will then store your new settings and reboot automatically.

You can now join the gateway to the rest of your network, provided you have not specified a duplicate IP Address. Any Computer on the network should now be able to access these configuration screens.

## Configuration of Gateway

### Pre-configuration

This gateway is, by default, configured for 8 Vitotronic 300, GW6B boiler controls and 3 zones. If a boiler reports 0 degrees for the boiler water temperature, all other points pertaining to that boiler will be skipped. This speeds up the refresh rate for all available points, as the gateway isn't polling information from a boiler that isn't there.

Applications which use the Viessmann Vitotronic 300, GW6B as a master cascade control will need to have the control to be addressed as LON 1 at coding address 77 for the "master or lead" boiler. Subsequent boiler LON addresses should be set from 2 to 8.

### Vitodens 200, B2HA

This gateway has two configuration variables, the first is the **AO2 Cascade Config**, which programs a Cascade Address of 9 for the Vitotronic 300-K, MW2C cascade control. The MW2C must also be set to LON address 77 to a value of 9. This allows

a full system of boilers to be set from 77 LON address 1 through 8 for the boilers. This assumes that the boiler communication is via LON and not KMK.

The second configuration is the **AO3 Comm Config**. If KMK communication between the boilers and Vitotronic 300-K, MW2C exists, object AO3 must be set to a value of 1. The information that is available via KMK is less than it would be if LON were used.

## Gateway Features Overview

### Service LED

The service LED toggles according to how much information is being exchanged between the gateway and the boilers, it is **not** affected by the communication between the gateway and the BMS. In a single boiler system, the LED will toggle very slowly while retrieving boiler information, but will speed up when retrieving cascade information. In a multi-boiler system, the LED will have a more uniform blinking rate.

### Timeout Feature

If a boiler doesn't report any information for 10 minutes, the gateway will assume the boiler is offline, and will report a value of zero for all the points associated with that boiler.

This is only applicable for LON communication between the boilers, not KMK communication.

### Fault Codes (GW6B)

The lead boiler will report whenever any lag boiler has a fault. The gateway will not report these faults to the BMS. By doing this, it will prevent the lead boiler from looking like it is experiencing a fault when it's actually a lag boiler that has the current fault.

The gateway will however report the fault code for the boiler experiencing an issue under the corresponding boiler fault point. To clarify, the boiler 1 fault point will only display faults being experienced by the lead boiler (boiler 1).

Someone on site may get confused if the physical control is indicating a fault, and the gateway isn't reporting it.

## BACnet Object Overview—Writable Analog Outputs

### Configuration and AO Objects

Values which can be written to the Versatronik 585 VI/BACIP Gateway

#### Note:

Temperature values only possible with specific installed sensors based on particular installation

Object ID	Name	Point Description
<b>AO1</b>	<b>Unit Setting</b>	0 (default)=Celsius temperature setting 1=Fahrenheit temperature Setting
<b>AO2</b>	<b>Cascade Config</b>	0 (default)=Cascade control at LON address 1 Vitotronic 300 GW6B (Lead) 1=Cascade control at LON address 9 for Vitotronic 300-K, MW2C
<b>AO3</b>	<b>Comm Config</b>	0 (default)=LON communications between boilers and Cascade 1=KMK communications between boilers and Cascade
AO4	DHW Set Point	DHW Set Point Temperature writeable
AO5	HC1 Shift	Heating Circuit 1 Shift setting for outdoor reset heating curve
AO6	HC1 Slope	Heating Circuit 1 Slope setting for outdoor reset heating curve
AO7	HC1 Room Normal	Heating Circuit 1 Room Normal setting (Sun setting)
AO8	HC1 Room Reduced	Heating Circuit 1 Room Reduced setting (Moon setting)
<b>AO9</b>	<b>HC1 Supply Set-point</b>	Heating Circuit 1 Supply Set Point (LLH/Common Supply Set Point)
AO10	HC2 Shift	Heating Circuit 2 Shift setting for outdoor reset heating curve
AO11	HC2 Slope	Heating Circuit 2 Slope setting for outdoor reset heating curve
AO12	HC2 Room Normal	Heating Circuit 2 Room Normal setting (Sun setting)
AO13	HC2 Room Reduced	Heating Circuit 2 Room Reduced setting (Moon setting)
AO14	HC2 Supply Setpoint	Heating Circuit 2 Supply Set Point (Mixing Valve 2)
AO15	HC3 Shift	Heating Circuit 3 Shift setting for outdoor reset heating curve
AO16	HC3 Slope	Heating Circuit 3 Slope setting for outdoor reset heating curve
AO17	HC3 Room Normal	Heating Circuit 3 Room Normal setting (Sun setting)
AO18	HC3 Room Reduced	Heating Circuit 3 Room Reduced setting (Moon setting)
AO19	HC3 Supply Setpoint	Heating Circuit 3 Supply Set Point (Mixing Valve 3)



## BACnet Points Overview—Readable Analog Input Objects

### Analog Input Variables

Values which can be read from the Versatronik 585 VI/BACIP Gateway

#### Note:

Temperature values only possible with specific installed sensors based on particular installation

Object ID	Name
AI1	BOILER 1 ACTUAL TEMPERATURE
AI2	BOILER 1 ACTUAL RETURN TEMPERATURE 17A (If sensor installed/available/possible)
AI3	BOILER 1 MODULATION %
AI4	BOILER 1 FLUE GAS ACTUAL TEMPERATURE (If sensor installed/available/possible)
AI5	BOILER 1 FAULT CODE Will display actual fault code for LON communication, but for KMK, a 1 will be seen for fault and 0 for no fault.
AI6	BOILER 1 PUMP STATUS (29 output) (1=ON, 0=OFF) No pump status with KMK communication
AI7	BOILER 2 ACTUAL TEMPERATURE
AI8	BOILER 2 ACTUAL RETURN TEMPERATURE 17A (If sensor installed/available/possible)
AI9	BOILER 2 MODULATION %
AI10	BOILER 2 FLUE GAS ACTUAL TEMPERATURE (If sensor installed/available/possible)
AI11	BOILER 2 FAULT CODE Will display actual fault code for LON communication, but for KMK, a 1 will be seen for fault and 0 for no fault.
AI12	BOILER 2 PUMP STATUS (29 output) (1=ON, 0=OFF) No pump status with KMK communication
AI13	BOILER 3 ACTUAL TEMPERATURE
AI14	BOILER 3 ACTUAL RETURN TEMPERATURE 17A (If sensor installed/available/possible)
AI15	BOILER 3 MODULATION %
AI16	BOILER 3 FLUE GAS ACTUAL TEMPERATURE (If sensor installed/available/possible)
AI17	BOILER 3 FAULT CODE Will display actual fault code for LON communication, but for KMK, a 1 will be seen for fault and 0 for no fault.
AI18	BOILER 3 PUMP STATUS (29 output) (1=ON, 0=OFF) No pump status with KMK communication
AI19	BOILER 4 ACTUAL TEMPERATURE
AI20	BOILER 4 ACTUAL RETURN TEMPERATURE 17A (If sensor installed/available/possible)
AI21	BOILER 4 MODULATION %
AI22	BOILER 4 FLUE GAS ACTUAL TEMPERATURE (If sensor installed/available/possible)
AI23	BOILER 4 FAULT CODE Will display actual fault code for LON communication, but for KMK, a 1 will be seen for fault and 0 for no fault.
AI24	BOILER 4 PUMP STATUS (29 output) (1=ON, 0=OFF) No pump status with KMK communication

## BACnet Points Overview—Readable Analog Input Objects Continued

### Analog Input Variables

Values which can be read from the Versatronik 585 VI/BACIP Gateway

#### Note:

Temperature values only possible with specific installed sensors based on particular installation

Point	Point Description
AI25	BOILER 5 ACTUAL TEMPERATURE
AI26	BOILER 5 ACTUAL RETURN TEMPERATURE 17A (If sensor installed/available/possible)
AI27	BOILER 5 MODULATION %
AI28	BOILER 5 FLUE GAS ACTUAL TEMPERATURE (If sensor installed/available/possible)
AI29	BOILER 5 FAULT CODE Will display actual fault code for LON communication, but for KMK, a 1 will be seen for fault and 0 for no fault.
AI30	BOILER PUMP STATUS (29 output) (1=ON, 0=OFF) No pump status with KMK communication
AI31	BOILER 6 ACTUAL TEMPERATURE
AI32	BOILER 6 ACTUAL RETURN TEMPERATURE 17A (If sensor installed/available/possible)
AI33	BOILER 6 MODULATION %
AI34	BOILER 6 FLUE GAS ACTUAL TEMPERATURE (If sensor installed/available/possible)
AI35	BOILER 6 FAULT CODE Will display actual fault code for LON communication, but for KMK, a 1 will be seen for fault and 0 for no fault.
AI36	BOILER 6 PUMP STATUS (29 output) (1=ON, 0=OFF) No pump status with KMK communication
AI37	BOILER 7 ACTUAL TEMPERATURE
AI38	BOILER 7 ACTUAL RETURN TEMPERATURE 17A (If sensor installed/available/possible)
AI39	BOILER 7 MODULATION %
AI40	BOILER 7 FLUE GAS ACTUAL TEMPERATURE (If sensor installed/available/possible)
AI41	BOILER 7 FAULT CODE Will display actual fault code for LON communication, but for KMK, a 1 will be seen for fault and 0 for no fault.
AI42	BOILER 7 PUMP STATUS (29 output) (1=ON, 0=OFF) No pump status with KMK communication
AI43	BOILER 8 ACTUAL TEMPERATURE
AI44	BOILER 8 ACTUAL RETURN TEMPERATURE 17A (If sensor installed/available/possible)
AI45	BOILER 8 MODULATION %
AI46	BOILER 8 FLUE GAS ACTUAL TEMPERATURE (If sensor installed/available/possible)
AI47	BOILER 8 FAULT CODE Will display actual fault code for LON communication, but for KMK, a 1 will be seen for fault and 0 for no fault.
AI48	BOILER 8 PUMP STATUS (29 output) (1=ON, 0=OFF) No pump status with KMK communication

## BACnet Points Overview—Readable Analog Input Objects Continued

### Input Variables

Values which can be read from the Versatronik 585 VI/BACIP Gateway

#### Note:

Temperature values only possible with specific installed sensors based on particular installation

Point	Point Description
AI49	CASCADE OUTDOOR TEMPERATURE
AI50	CASCADE RELAY STATE
AI51	CASCADE FAULT CODE
AI52	CASCADE DHW SET-POINT
AI53	CASCADE DHW ACTUAL TEMPERATURE
AI54	CASCADE HC1 SUPPLY SET-POINT
AI55	CASCADE HC1 SUPPLY ACTUAL TEMPERATURE
AI56	CASCADE HC1 SUPPLY RETURN TEMPERATURE
AI57	CASCADE HC1 CURVE SHIFT
AI58	CASCADE HC1 CURVE SLOPE
AI59	CASCADE HC1 ROOM TEMP. NORMAL
AI60	CASCADE HC1 ROOM TEMP. REDUCED
AI61	CASCADE HC2 SUPPLY SET-POINT
AI62	CASCADE HC2 SUPPLY ACTUAL TEMPERATURE
AI63	CASCADE HC2 CURVE SHIFT
AI64	CASCADE HC2 CURVE SLOPE
AI65	CASCADE HC2 ROOM TEMP. NORMAL
AI66	CASCADE HC2 ROOM TEMP. REDUCED
AI67	CASCADE HC3 SUPPLY SET-POINT
AU68	CASCADE HC3 SUPPLY ACTUAL TEMPERATURE
AI69	CASCADE HC3 CURVE SHIFT
AI70	CASCADE HC3 CURVE SLOPE
AI71	CASCADE HC3 ROOM TEMP. NORMAL
AI72	CASCADE HC3 ROOM TEMP. REDUCED

## MW2C Cascade Relay States (Not applicable for GW6B Cascade)

Values which can be read from the Versatronik 585 VI/BACIP Gateway. Limitations exist with KMK communication between boilers and cascade control.

Point	Point Description
nvoRelayState_bit0	bit 2 <sup>0</sup> : DHW tank loading pump (Pump connection output 21)
nvoRelayState_bit1	bit 2 <sup>1</sup> : Re-circulation pump (Pump connection output 28)
nvoRelayState_bit2	bit 2 <sup>2</sup> : Heating circuit pump 1 (Pump connection 20A1/M1)
nvoRelayState_bit3	bit 2 <sup>3</sup> : Heating circuit pump 2 (Pump connection 20M2)
nvoRelayState_bit4	bit 2 <sup>4</sup> : Heating circuit pump 3 (Pump connection 20M3)
nvoRelayState_bit5	bit 2 <sup>5</sup> : Night-time contact HKP 1
nvoRelayState_bit6	bit 2 <sup>6</sup> : Night-time contact HKP 2
nvoRelayState_bit7	bit 2 <sup>7</sup> : Night-time contact HKP 3
nvoRelayState_bit8	bit 2 <sup>8</sup> : Supply pump
nvoRelayState_bit9	bit 2 <sup>9</sup> : Primary pump heat exchanger set for DHW tank loading
	bit 2 <sup>9</sup> : DHW tank pump
nvoRelayState_bit10	bit 2 <sup>10</sup> : Boiler circuit and common supply pump (Pump 29)
	bit 2 <sup>10</sup> : Internal Pump
nvoRelayState_bit11	bit 2 <sup>11</sup> : Shunt pump
	bit 2 <sup>11</sup> : Diverting valve in space heating position
nvoRelayState_bit12	bit 2 <sup>12</sup> : Flue gas heat exchanger pump
nvoRelayState_bit13	bit 2 <sup>13</sup> : ThermControl switching contact
	bit 2 <sup>13</sup> : Diverting valve in DHW position
nvoRelayState_bit14	bit 2 <sup>14</sup> : Burner 1 <sup>st</sup> stage
nvoRelayState_bit15	bit 2 <sup>15</sup> : Burner fault
	bit 2 <sup>15</sup> : Compiled fault

## Fault Codes

### Appendix A—Fault Codes

Error codes for Viessmann control units based on controls/equipment installed

Fault Code (hex)	Fault Code (Dec)	Description
00	00	System without fault
0F	15	Perform maintenance check-up
10	16	Short circuit, outdoor temperature sensor
18	24	Interruption, outdoor temperature sensor
20	32	Short circuit, supply temperature sensor HC1/system
28	40	Interruption, supply temperature sensor HC1/system
30	48	Short circuit, boiler water temperature sensor
38	56	Interruption, boiler water temperature sensor
40	64	Short circuit, supply temperature sensor heating circuit 2
41	65	Short circuit, return temperature sensor heating circuit 2
44	68	Short circuit, supply temperature sensor heating circuit 3
45	69	Short circuit, return temperature sensor heating circuit 3
48	72	Interruption, supply temperature sensor heating circuit 2
49	73	Interruption, return temperature sensor heating circuit 2
4C	76	Interruption, supply temperature sensor heating circuit 3
4d	77	Interruption, return temperature sensor heating circuit 3
50	80	Short circuit, DHW tank temperature sensor
51	81	Short circuit, DHW tank temperature sensor 2
58	88	Interruption, DHW tank temperature sensor
59	89	Interruption, DHW tank temperature sensor 2
60	96	Short circuit, return temperature sensor 17
68	104	Interruption, return temperature sensor 17
70	112	Short circuit, supply/return temperature sensor 17B
78	120	Interruption, supply/return temperature sensor 17B
92	146	Solar: collector temperature short circuit
93	147	Solar: collector return temperature short circuit
94	148	Solar: collector DHW tank temperature sensor short circuit
9A	154	Solar: collector temperature sensor open circuit
9B	155	Solar collector return temperature sensor open circuit
9C	156	Solar: DHW tank temperature sensor open circuit
9F	159	Solar: general fault message
A7	167	Fault control unit wireless clock module
AE	174	Internal fault mixing valve
AF	175	Internal fault mixing valve
b0	176	Short circuit, flue gas temperature sensor
b1	177	Communication fault, programming unit (internal)
b4	180	Internal fault
b5	181	Internal fault
b6	182	Internal fault, invalid hardware recognition
b7	183	Internal fault, boiler protection coding card
b8	184	Interruption, flue gas temperature sensor
bA	186	Fault, mixing valve module (KM-BUS)
bC	188	Fault, Vitotrol heating circuit 1 (KM-BUS)
bd	186	Fault, Vitotrol heating circuit 2 (KM-BUS)
bE	190	Fault, Vitotrol heating circuit 3 (KM-BUS)
C1	193	External fault indication, boiler
C2	194	Communication fault solar control unit (KM-BUS)

## Fault Codes Continued

### Appendix A—Fault Codes Continued

Error codes for Viessmann control units based on controls/equipment installed

Fault Code (hex)	Fault Code (Dec)	Description
C5	197	Fault, speed controlled pump heating circuit 1 (KM-BUS)
C6	198	Fault, speed controlled pump heating circuit 2 (KM-BUS)
C7	199	Fault, speed controlled pump heating circuit 3 (KM-BUS)
C8	200	Fault, water level control
C9	201	Fault, maximum pressure
CA	202	Fault, minimum pressure/maximum pressure 2
Cb	203	Fault, maximum pressure 2
CC	204	Reserved, external periphery
Cd	205	Communication fault, Vitocom 300 (KM-BUS)
CE	206	Communication fault, fault indicator module (KM-BUS)
CF	207	Communication fault: wrong LON module
d1	209	Burner fault, boiler
d4	212	Fixed high limit fault, boiler
d5	213	Cascade: boiler is not responding
d6	214	External fault 1, plug-in adaptor
d7	215	External fault 2, plug-in adaptor
d8	216	External fault 3, plug-in adaptor
dA	218	Short circuit, room temperature sensor heating circuit 1
db	219	Short circuit, room temperature sensor heating circuit 2
dC	220	Short circuit, room temperature sensor heating circuit 3
dd	221	Interruption, room temperature sensor heating circuit 1
dE	222	Interruption, room temperature sensor heating circuit 2
dF	223	Interruption, room temperature sensor heating circuit 3
E0	224	Fault, external participant/device connected to LON
E4	228	Fault power supply voltage
E5	229	Internal fault combustion control unit
E6	230	Flue gas/air supply system blocked
F0	240	Communication fault combustion control unit
F1	241	Flue gas temperature limit has tripped
F2	242	Temperature limit has tripped
F3	243	Flame signal is present at burner start
F4	244	Flame signal is not present
F5	245	Air pressure switch not open for burner start
F6	246	Gas pressure switch not open for burner start
F7	247	Air pressure sensor short circuit or offset value outside of tolerances
F8	248	Fuel valve closure delayed
F9	249	Blower speed too low at burner start
FA	250	Blower speed too high at burner start
FC	252	Control of modulation valve defective
FD	253	Fault combustion control unit
FE	254	Coding plug defective or wrong EMV error
FF	255	Internal fault

## Additional Alarm/Fault Information for Tridium Based BMS

Viessmann controls show fault codes in hexadecimal format to conserve screen space on the user interface of the boiler and system controls. The Versatronik 585 gateway uses a SNVT\_count variable which is usually displayed in decimal format.

The base-format in which this fault can be displayed depends on your BMS software. This example shows how to display this fault code in hexadecimal, and Text format in Niagara AX.

To display in hex, you can use the KitControl -> Util "Numeric Bit And" object's mask input.

To display the equivalent fault text value, you can use the KitControl -> Conversion "Numeric To Enum" object and type out the enum range for all Viessmann error codes.

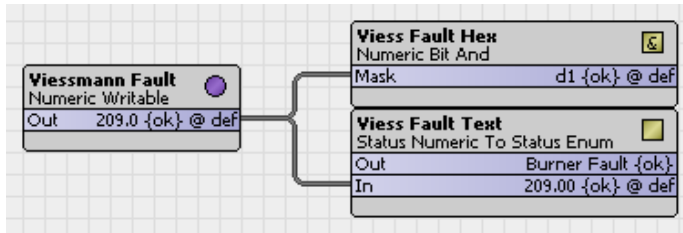

These values can now be displayed on a px webpage by pointing a Bound Label to the appropriate slot values.

Fault Code: d1 (Burner Fault)

### NOTE!

Fault codes come in as decimal numbers (base 10) and need to be converted to hexadecimal (base 16) to be a proper representation of the Viessmann fault code.

# Technical Information—120VAC

KWE P/N 394066 Versatronik 585 and 585D GW5/6 and B2HA BACIP Gateway V1.0 02/2016 Technical information subject to change without notice

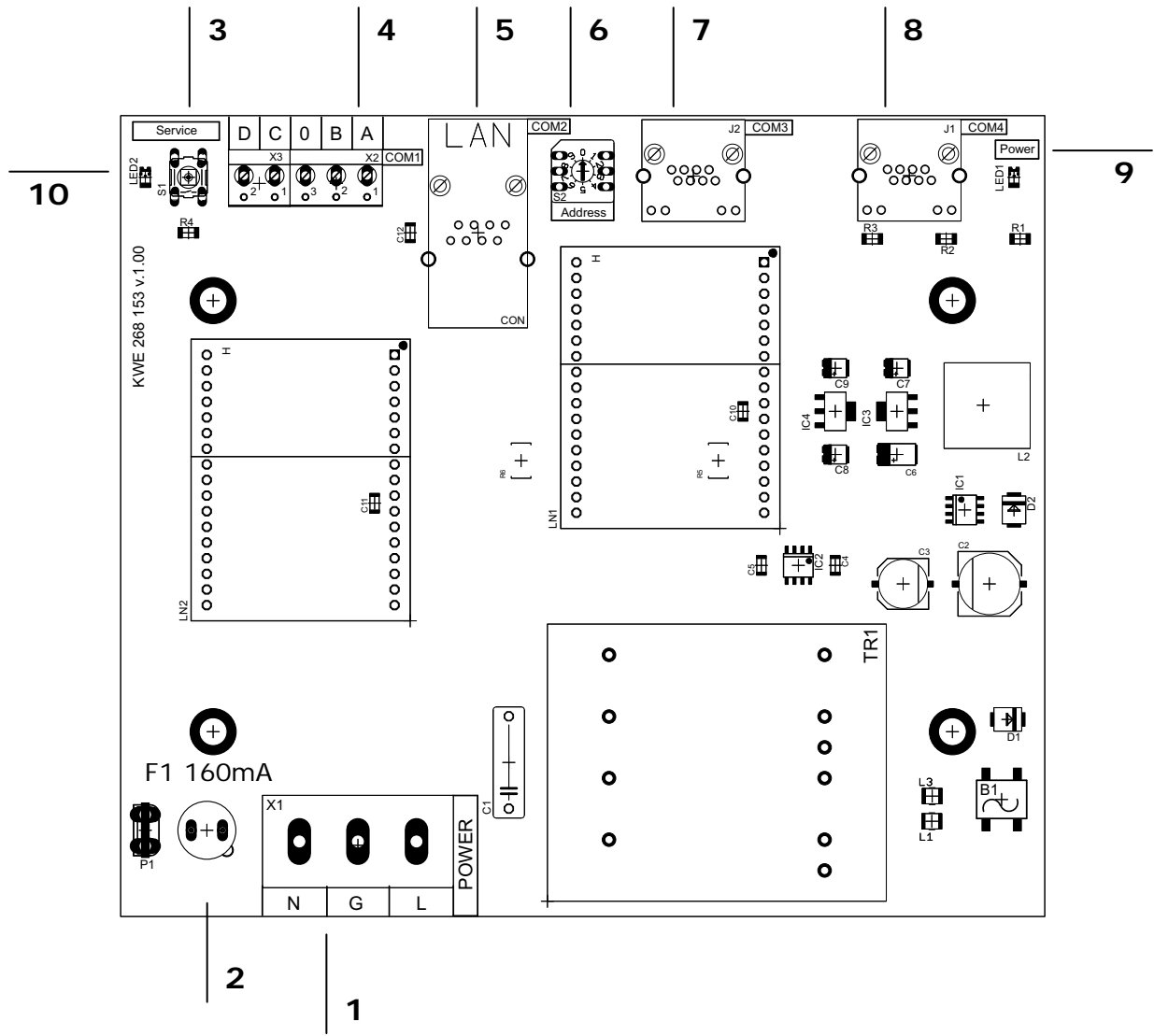

## PCB Identifiers

1	120VAC Power Supply Connections
2	Fuse
3	Service Button
4	BACNET Connections to BMS
5	RJ45 Connection to BMS BACnet
6	Addressing selector for multiple modules
7	COM3 for multiple BUS connections
8	COM4 RJ45 Connection to control
9	Power LED indicator
10	Service LED

## Specifications

Voltage Requirements	120VAC
Fuse Rating	160mA Time Delay
Power	4VA
Communication Connections	Supplied cable between devices

**CAUTION**

Static sensitive components may be damaged by improper handling or work within the control. Ensure all possible measures are taken to eliminate build-up of static electricity.



# Technical Information

KWE P/N 394066 Versatronic 585 and 585D GW5/6 and B2HA BACIP Gateway V1.0 02/2016 Technical information subject to change without notice

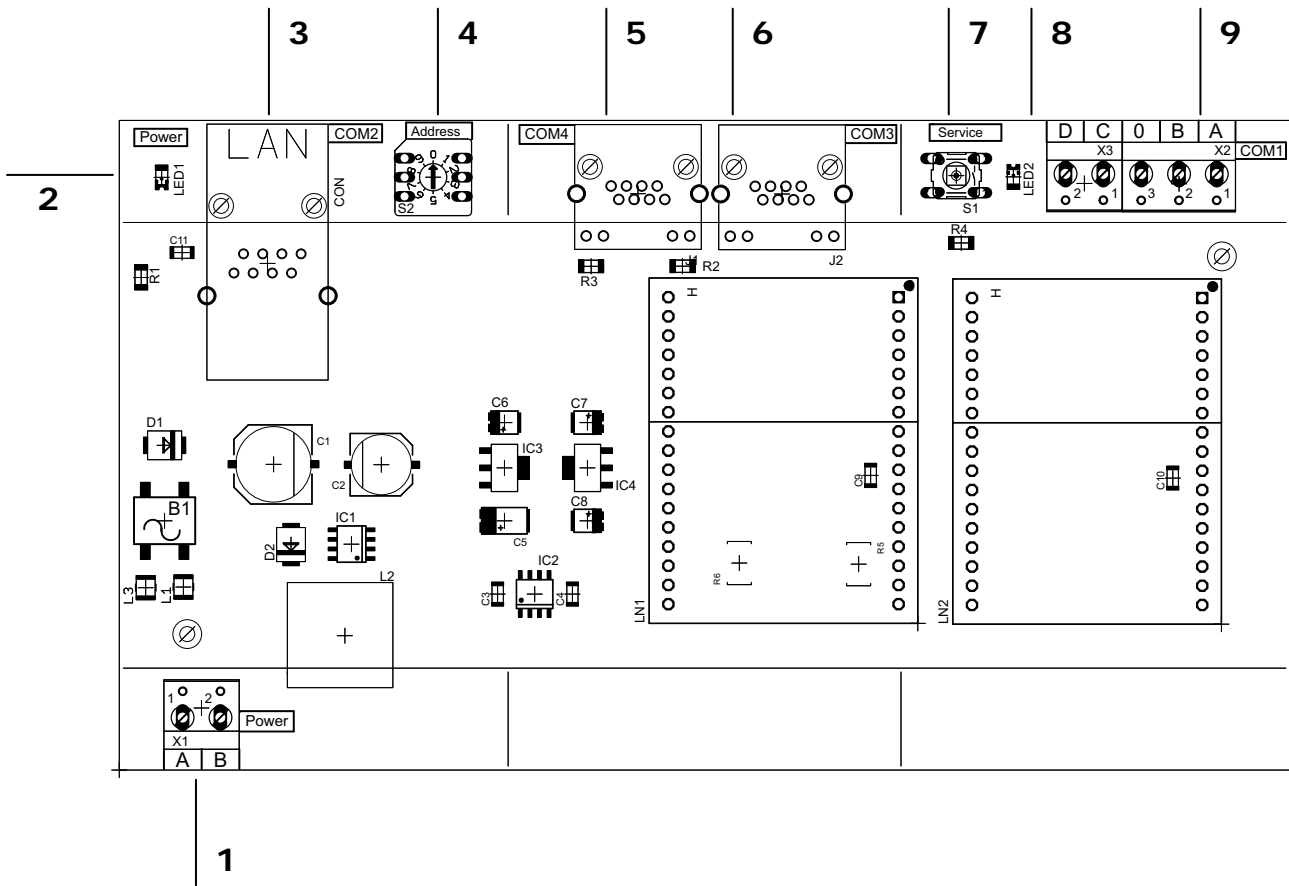

## PCB Identifiers

1	24VAC Power Supply Connections
2	Power LED indicator
3	BACnet RJ45 BMS Connection
4	Addressing dial for multiple units
5	COM4 RJ45 Connection to control
6	COM3 for multiple BUS connections
7	Service button
8	Service LED
9	BACNET Connections to BMS

## Specifications

Voltage Requirements	24VAC
Fuse Rating	N/A
Power	4VA
Communication Connections	Supplied cable between devices



**CAUTION**

Static sensitive components may be damaged by improper handling or work within the control. Ensure all possible measures are taken to eliminate build-up of static electricity.

KWE Technologies Group  
750 McMurray Road  
Waterloo, Ontario, Canada  
N2V 2G5  
Tel: (519) 747-5042  
Fax: (519) 747-4448  
[www.kwe-tech.com](http://www.kwe-tech.com)  
[info@kwe-tech.com](mailto:info@kwe-tech.com)

